

Schottky Barrier Diode

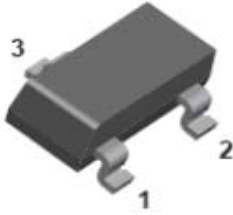

Features

- Epoxy meets UL-94 V-0 flammability rating
- Moisture Sensitivity Level 1
- Low Forward Voltage
- Surface Mount device

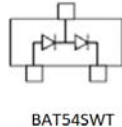
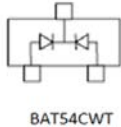
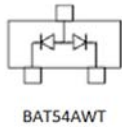
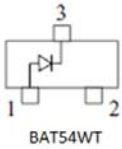

Mechanical Data

- **Package:** SOT-323
- **Terminals:** Tin plated leads, solderable per J-STD-002 and JESD22-B102
- **Marking:**

BAT54WT	KL5
BAT54AWT	KL6
BAT54CWT	KL7
BAT54SWT	KL8

■ Maximum Ratings ($T_A=25^\circ\text{C}$ Unless otherwise specified)

Item	Symbol	Unit	Value
Continuous Reverse Voltage	V_R	V	30
Forward Continuous Current	I_F	mA	200
Non-Repetitive Peak Forward Surge Current @ $t < 1\text{s}$	I_{FSM}	A	0.6
Total Power Dissipation @ $T_A=25^\circ\text{C}$	P_D	mW	200
Thermal Resistance, Junction to Ambient	R_{thJA}	$^\circ\text{C}/\text{W}$	500
Operation Junction Temperature	T_J	$^\circ\text{C}$	-55 to +125
Storage Temperature	T_{STG}	$^\circ\text{C}$	-55 to +125

■ Ordering Information (Example)

PREFERRED P/N	PACKING CODE	UNIT WEIGHT(g)	MINIMUM PACKAGE(pcs)	INNER BOX QUANTITY(pcs)	OUTER CARTON QUANTITY(pcs)	DELIVERY MODE
BAT54WT	F2	Approximate 0.005	3000	30000	120000	7" reel
BAT54AWT	F2	Approximate 0.005	3000	30000	120000	7" reel
BAT54CWT	F2	Approximate 0.005	3000	30000	120000	7" reel
BAT54SWT	F2	Approximate 0.005	3000	30000	120000	7" reel



BAT54WT THRU BAT54SWT

■ Electrical Characteristics (Ta=25°C Unless otherwise specified)

Item	Symbol	Unit	Conditions	Value
Maximum Instantaneous Forward Voltage	V_F	V	$I_{FM}=0.1mA$	0.24
			$I_{FM}=1mA$	0.32
			$I_{FM}=10mA$	0.4
			$I_{FM}=30mA$	0.5
			$I_{FM}=100mA$	1
Maximum DC Reverse Current	I_R	μA	$V_R=25V$	2
Typical Junction Capacitance	C_J	pF	$f=1.0MHz, V_R=1.0V$	10
Maximum Reverse Recovery Time	T_{rr}	ns	$I_F=I_R=10mA$ $I_{rr}=0.1 \cdot I_R, R_L=100\Omega$	5

■ Typical Characteristics

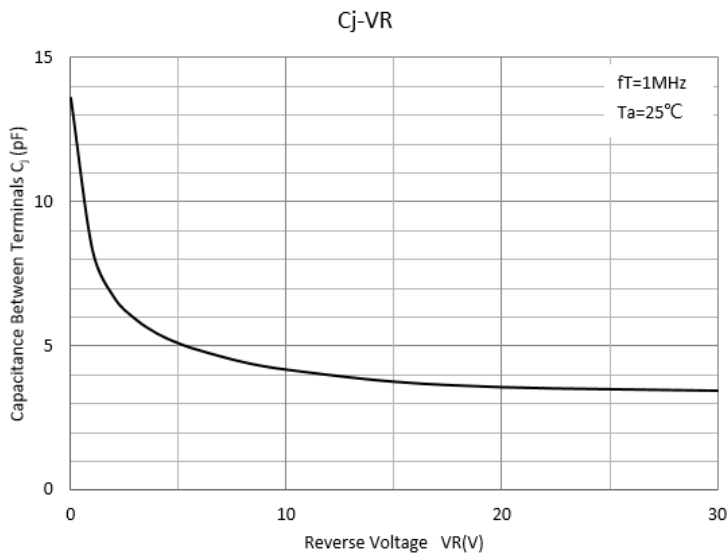
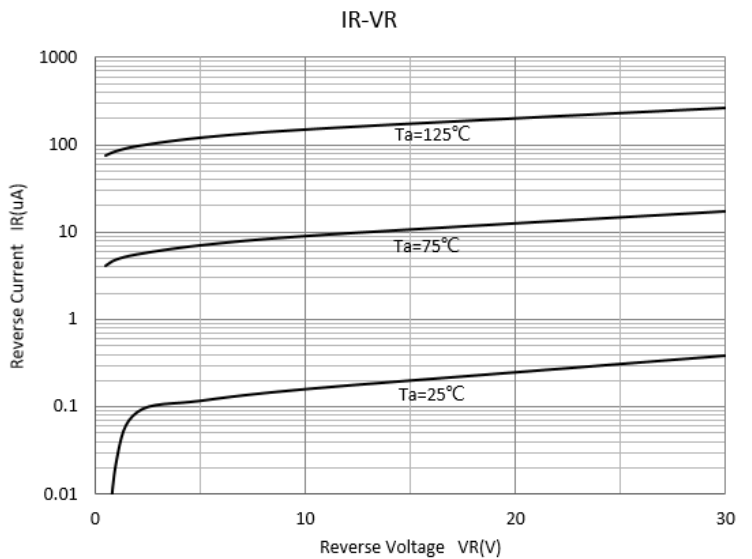
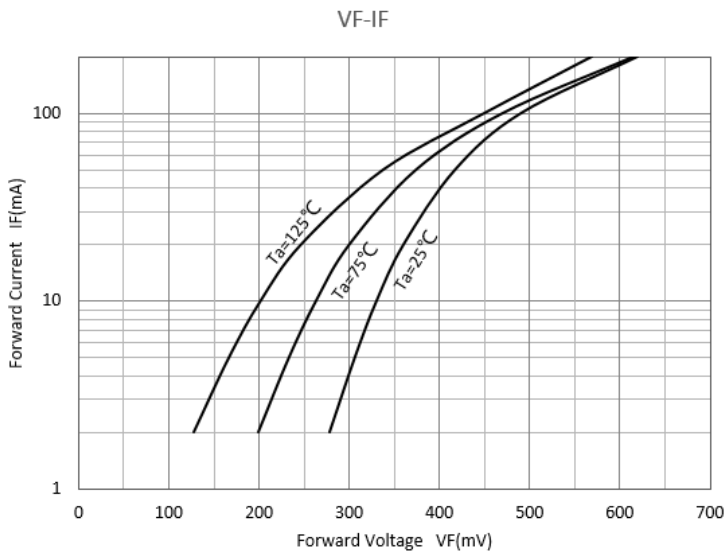



BAT54WT THRU BAT54SWT

■ SOT-323 Package Outline Dimensions

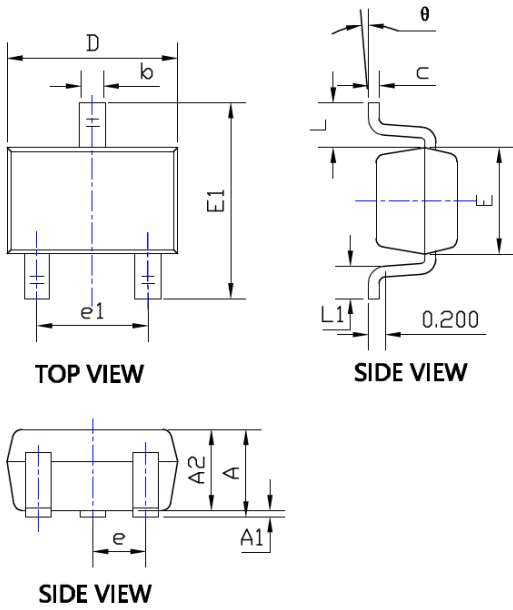

SYMBOL	DIMENSIONS			
	INCHES		Millimeter	
	MIN.	MAX.	MIN.	MAX.
A	0.035	0.043	0.900	1.100
A1	0.000	0.004	0.000	0.100
A2	0.035	0.039	0.900	1.000
b	0.006	0.016	0.150	0.400
c	0.004	0.010	0.100	0.250
D	0.071	0.087	1.800	2.200
E	0.045	0.053	1.150	1.350
E1	0.085	0.096	2.150	2.450
e	0.026TYP		0.650TYP	
e1	0.047	0.055	1.200	1.400
L	0.021REF		0.525REF	
L1	0.010	0.018	0.260	0.460
θ	0°	8°	0°	8°

■ SOT-323 Suggested Pad Layout

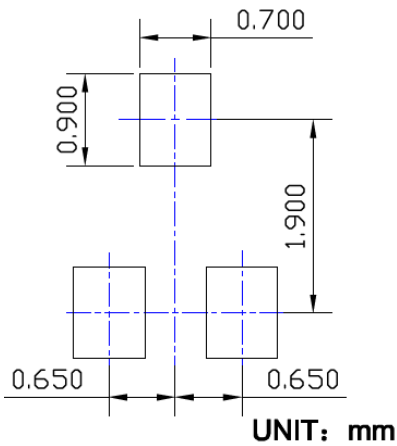



BAT54WT THRU BAT54SWT

Disclaimer

The information presented in this document is for reference only. Yangzhou Yangjie Electronic Technology Co., Ltd. reserves the right to make changes without notice for the specification of the products displayed herein to improve reliability, function or design or otherwise.

The product listed herein is designed to be used with ordinary electronic equipment or devices, and not designed to be used with equipment or devices which require high level of reliability and the malfunction of which would directly endanger human life (such as medical instruments, transportation equipment, aerospace machinery, nuclear-reactor controllers, fuel controllers and other safety devices), Yangjie or anyone on its behalf, assumes no responsibility or liability for any damages resulting from such improper use of sale.

This publication supersedes & replaces all information previously supplied. For additional information, please visit our website [http:// www.21yangjie.com](http://www.21yangjie.com) , or consult your nearest Yangjie's sales office for further assistance.